



TRUCK AND VAN EQUIPMENT

# OPERATORS MANUAL

STEEL & ALUMINUM SIDE BOX

MODELS 164-X-01 THRU 186-X-01

WWW.WEATHERGUARD.COM



## PRODUCT REGISTRATION

Model #: \_\_\_\_\_ Serial #: \_\_\_\_\_

For your convenience,  
place product registration  
tear-off sticker here

Purchase Date: \_\_\_\_\_

Place of Purchase: \_\_\_\_\_

Key Code: \_\_\_\_\_











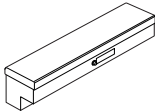
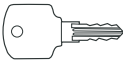

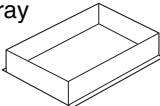

## INSTALLATION TIME

Approximate installation time: 48 minutes (0.8 hr.) depending on installer experience.

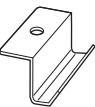
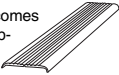
## TOOLS REQUIRED

- 1/2" deep well ratchet wrench
- 1/2" open or box end wrench
- 9/16" open or box end wrench
- Drill with 3/16", 3/8", and 1/2" drill bit
- Carpenter's square

## PARTS LIST

(1) Side Box 	(2) Keys 	(1) 5/16"-18 x 2 1/4" Black Oxide Hex Head Bolt 	(2) 5/16"-18 x 2 1/4" Hex Head Bolt 
(1) Small Parts Tray 	(10) 5/16" Flat Washers 	(1) 3/4" Round Cap Plug 	(2) Fender Washers 
(2) Legs 	(8) 5/16" Lock Washers 	(8) 5/16"-18 x 1 1/4" Hex Head Bolts 	(2) Mounting Clamps 
(2) Rubber Mounting Pads  <small>Note: The rubber mounting pad comes as a single piece and must be separated into two pieces, one for each side of the truck.</small>	(8) 5/16"-18 Blind Fasteners 	(1) 5/16"-18 Nylon Lock Nut 	(1) "J" Bolt 
(1) Side to Cross Box Mounting Angle 	(1) Installation Tool 	(1) Retaining Washer 	

## -ATTENTION-

Read and understand all instructions and warnings before operating or using this product.



## DANGER

Danger of explosion. Do not use this product for storing or transporting flammables, explosives, hazardous materials, or hazardous waste, such as containers of gasoline, solvents, gun powder, dynamite, propane tanks, acetylene tanks and cutting torches. This product is only intended and safe for use in storing and transporting small tools, equipment and other similar materials. Any modifications made to, or unintended use of this product, could create a hazardous condition that can cause death, serious personal injury or property damage.

**CAUTION**

Before marking the leg mounting holes, check inside the box for location of gas spring housing and components that may obstruct safe drilling.

**CAUTION**

To keep debris out of your eyes when checking the underside of the vehicle, or when drilling, always wear eyewear.

**WARNING**

Prior to drilling, so as not to cut or puncture fuel tanks, fuel lines, brake lines, electric wires, etc., check under vehicle for locations.

**WARNING**

All floor mounting bolts near the gas tank area should be installed from the underside of the vehicle, to guard against the gas tank being punctured in the event of a collision. This would mean not using Blind Fastener in this area. Holes drilled in this area should be 3/8".

**INSTALLATION INSTRUCTIONS**

**Note:**

- If your pickup is fitted with a plastic drop-in bed liner, it may need to be drilled, trimmed, or cut for proper installation of truck box.
- Truck box cover may not properly latch until box is fully bolted to truck bed.
- Periodically check tightness of mounting bolts to insure proper attachment.
- Use touch-up paint on any drill holes to prevent oxidation.
- Install boxes with vehicle parked on level ground.

**Step 1: LOCATE BOX IN TRUCK BED**

- Mount Saddle/Cross Box first (if applicable).
- Place rubber mounting pads on bed rails.
- Place box into position on top of mounting pads.
- Support box with blocking until mounted.
- Square box to bed and level box so top is horizontal when viewed from rear.
- Leave 1/8" gap between side box and saddle/cross box (if applicable).
- Make sure cover opens fully without interference.

**Note:** Fasten leg mounting feet directly to bed floor, not bed liners or mats.

**Step 2: MARK AND DRILL MOUNTING HOLES**

- Position rear leg as shown in Figure 1. Use square to ensure vertical orientation.
- Mark both holes at top of leg and both holes in truck bed floor.

**Note:** To maintain full floor width between wheel wells, legs should be aligned with the inside edge of wheel wells. The foot of the leg must be squarely mounted on or between the tops of floor ribs.

- Repeat leg placement and marking process for other leg. If installing side boxes with a saddle or cross box, the front leg can be replaced with an angle bracket (see Figure 2).
- Remove box from truck
- Drill all marks on box and truck with 3/16" drill bit. Redrill all holes with 1/2" drill bit.
- Install all Blind Fasteners (see Figure 1, 2 and 4).

**Step 3: ATTACH BOX TO TRUCK BED**

**Note:** If you encounter interference with the mounting clamp and a stake pocket in the truck bed, it may be necessary to drill a 1/2" hole in the truck box and use the "J" bolt instead of mounting clamp.

**Note:** It is recommended that all fasteners be tightened hand tight first to ensure fit, then go back and fasten securely with wrench.

- Place box back in original position.
- Install all bolts in leg mounting feet as shown in Figure 3.
- Insert the two mounting clamps as shown in Figure 3.
- Snap Cap Plug into bottom hole (steel boxes only).

**Note:** Mounting clamp bolt may be difficult to turn due to the "lock nut" feature. Apply a small amount of grease to bolt threads prior to installation to ease assembly.

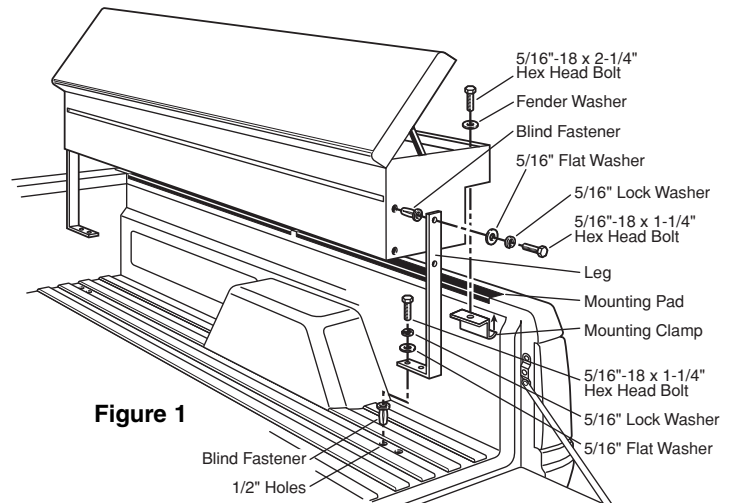

Figure 1

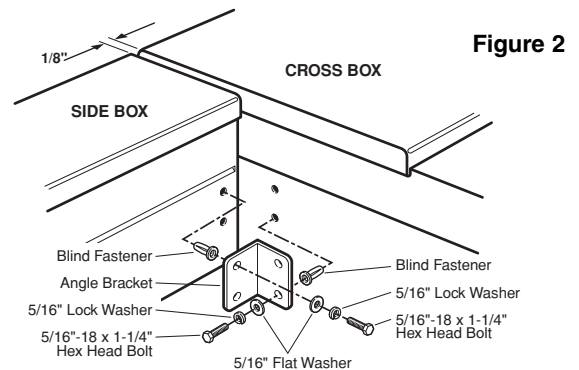

Figure 2

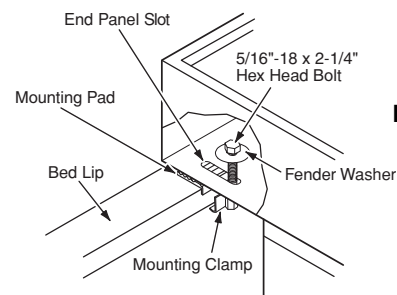

Figure 3

## BLIND FASTENER INSTALLATION

**Note:** Make sure there is enough hole depth before installing the Blind Fastener.

**Note:** Black Oxide Bolt, Flat Washer, and Installation Tool are only used to install Blind Fasteners.

- Install Blind Fastener using Fig. 4 as a guide.
- Place a drop of oil on black oxide bolt for lubrication.
- Insert Blind Fastener in the hole.
- Hold the "Installation Tool" with a 9/16" wrench while turning the "Black Oxide Bolt" with a 1/2" wrench until fully seated.
- Turning "Black Oxide Bolt" will be hard until fastener "bulbs" out.
- When Blind Fastener is fully seated, continue with installation.

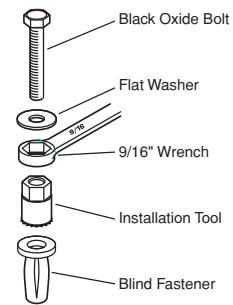

Figure 4

## FEATURE OPERATION

### LOCK SYSTEM

The WEATHER GUARD® Lock is designed to provide maximum security, while providing ease of use and years of reliable service. When in the locked mode, the button remains retracted in a tamper-resistant position. When the button is pressed in the unlock mode, the latch is activated and the cover opens.

### LOCK

Turn key counterclockwise to locked position as indicated on lock bezel. When the button is now pressed, it will stay in the retracted or tamper-resistant position until unlocked.

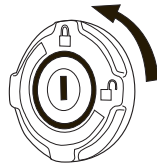

Turn key clockwise to unlock position as indicated on the lock bezel. Button will pop out and is now ready to release the latches when pressed.

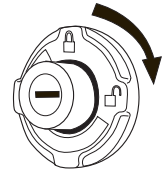

### LATCH SYSTEM

### UNLOCKED

The WEATHER GUARD Latch System utilizes an automotive grade latch in conjunction with a high strength latch striker to ensure maximum security. The WEATHER GUARD Latch System is designed to open with a single touch of the button, and close securely. Expect years of reliable service from the WEATHER GUARD Latch System with only minimal maintenance: Bi-annually lubricate latch pivot points with white grease. If latch striker is accidentally knocked out of alignment, simply use a mallet to re-align.

### MOUNTING BRACKETS

Wide flange mounting bolts provide secure mounting without crimping bed rails and allow full unobstructed use of side pockets.

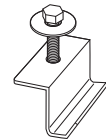

### 12V ELECTRICAL ACCESS

WEATHER GUARD Truck Boxes are equipped with a 12 Volt Electrical Access Plug for easy electrical accessory fit-ups. To use, simply cut along one or more perforations in the rubber grommet and run wire through.

Figure 5

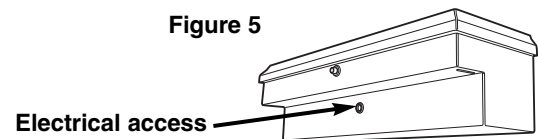

## WARNING

To prevent electric shock, explosion, fire and/or serious personal injury when using side box with:

### Extension Cord -

- Follow all Extension Cord manufacturer's warnings and instructions.
- Do NOT insert extension cord through hole without grommet in place (see Figure 5).
- Only use a three-wire extension cord with all three prongs intact. Never remove the round grounding prong.
- Extension cord must be connected to a 120 Volt GFCI protected outlet with proper ground. If GFCI outlet is not available, use an extension cord with GFCI protection built in.
- Check the insulation and plugs of extension cord before using. Do NOT use cord if it is worn or damaged.
- Do NOT overload extension cord.
- Remove extension cord from the grommet hole before moving or transporting side box.
- Only use an extension cord that is rated for outdoor use.
- Do NOT connect extension cord to outlet that also supplies critical safety equipment with power.

### Cordless Power Tool Battery Chargers -

- See Charger's Owner's Manual for proper use and care of charger and batteries. Follow all warnings and instructions provided with your battery charger.
- Place chargers and electrical connections in tray.
- Chargers are Dry location use only. Do NOT expose to liquid, vapor, or rain. Should your charger become wet, Do NOT attempt to use. Unplug extension cord from supply before handling wet charger or cords.
- Only use chargers and batteries that are intact and operating properly.
- Do NOT touch metal prongs when plugging charger into extension cord.
- Keep flammable materials like paper or rags away from charger, cords or connections.
- Do NOT place or attempt to charge lead acid, car-type batteries in side box.

## SERVICE PARTS

**FOR REPLACEMENT PARTS GO TO WWW.WEATHERGUARD.COM**

ITEM NO.	PART NO.	DESCRIPTION	FITS MODEL #
1		Gas Spring	165-X-01
1		Gas Spring	166-X-01
1	7095	Gas Spring	164-X-01, 174-X-01, 175-X-01, 184-X-01
1	7096	Gas Spring	176-X-01
1		Gas Spring	185-X-01
1		Gas Spring	186-X-01
2	7748-xx	Lock & Key Set (xx = key code) (1 lock, 2 keys, retainer clip)	All Side Boxes
3	7750-xx	Key Replacement (xx = key code) (2 keys)	All Side Boxes
4	7732	Latch & Striker Kit (1 latch, 1 striker, & mounting hardware)	All Side Boxes
5	7106	Striker Kit (1 Striker and mounting hardware)	All Side Boxes
6	7730	Weather Strip Kit (various styles for 1 box)	All Side Boxes
7	911	Tray	All Side Boxes
8	7734-x	Mounting Kit (2 clamps, 2 legs, 1 angle, 2 mount pads, related hardware)	All Side Boxes
9	7746	Nameplate Kit (3 stickers, 2 side bezels, 1 back bezel)	All Side Boxes
10	7749	Grommet Kit	All Side Boxes
11	7938-x	Cover	164-X-01
11	7939-x	Cover	174-X-01
11	7941-x	Cover	184-X-01
11	7887-x	Cover	165-X-01
11	7905-x	Cover	166-X-01
11	7906-x	Cover	175-X-01
11	7912-x	Cover	176-X-01
11	7914-x	Cover	185-X-01
11	7925-x	Cover	186-X-01

**Note:** In the model numbers above, X represents the color code for your model;  
0 = Clear, 3 = White, 5 = Black

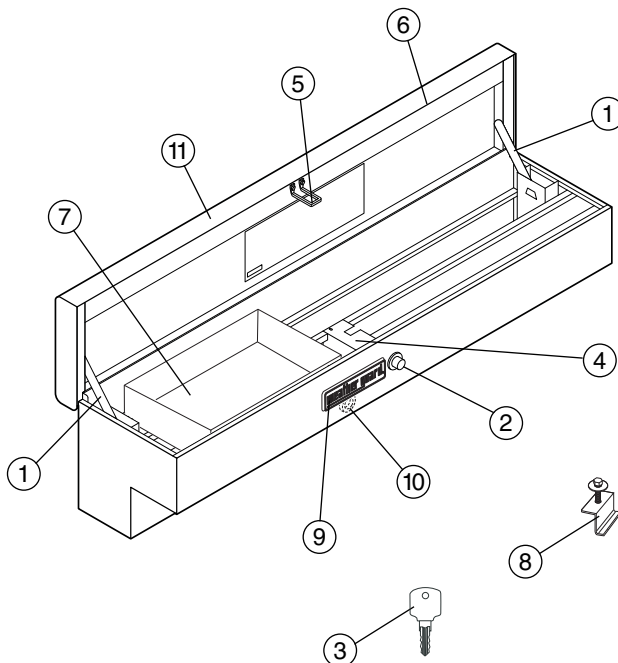

### -NOTICE-

Any modification or unintended use of this product shall immediately void all manufacturers warranties. Manufacturer disclaims all liability for injuries to persons or property resulting from any modification to, or unintended use of this product.

#### LIMITED WARRANTY

This LIMITED WARRANTY is made by Knaack Manufacturing Company, 420 E. Terra Cotta Ave., Crystal Lake, Illinois to the original retail purchaser of KNAACK® or WEATHER GUARD® products.

KNAACK MANUFACTURING COMPANY WARRANTS THAT KNAACK OR WEATHER GUARD PRODUCTS WILL BE FREE FROM DEFECTS IN MATERIAL AND WORKMANSHIP FOR A PERIOD OF THREE (3) YEARS FROM DATE OF PURCHASE BY THE ORIGINAL RETAIL PURCHASER.

If, before the expiration of the Warranty period, purchaser discovers that the KNAACK or WEATHER GUARD product fails to fulfill the Warranty, purchaser shall contact Knaack Manufacturing Company to make arrangements for an inspection of the product. If Knaack Mfg. Co. determines a defect exists, Knaack Mfg. Co. shall, at its option and expense, repair or replace any defective part. All Warranty repairs shall be made by an authorized KNAACK Product dealer or Knaack Mfg. Co. approved service company.

This Warranty shall not apply if the KNAACK or WEATHER GUARD product has been subjected to misuse, abnormal service or handling, improper maintenance, or alterations made by anyone other than a KNAACK or WEATHER GUARD Product dealer or a Knaack Mfg. Co. approved service company.

**THE WARRANTY PRINTED ABOVE IS THE ONLY WARRANTY APPLICABLE TO THIS PURCHASE. ALL OTHER WARRANTIES, EXPRESS OR IMPLIED, INCLUDING BUT NOT LIMITED TO THE IMPLIED WARRANTIES OF MERCHANTABILITY AND FITNESS FOR A PARTICULAR PURPOSE ARE HEREBY DISCLAIMED.**

**KNAACK MANUFACTURING COMPANY SHALL NOT BE LIABLE FOR ANY INCIDENTAL OR CONSEQUENTIAL DAMAGES ARISING OUT OF ANY BREACH OF THIS WARRANTY. NOR SHALL THE DAMAGES EXCEED THE RETURN AMOUNT OF THE PURCHASE PRICE PAID BY THE ORIGINAL PURCHASER.**

This Warranty is in lieu of all Warranties express or implied. The terms of this Warranty shall not be modified by any party, their successors or assigns. This Warranty gives you specific legal rights, and you may also have other rights which vary from state to state.

Product fits based on vehicle design available at the revision date. Vehicle manufacturers may change specs after the revision date, so if you have a vehicle produced with a model year date after the revision date, please contact your distributor or Knaack Mfg. Co. to verify fitting of product to vehicle.

WEATHER GUARD Products are protected by one or more of the following patents: U.S. 5145087, 5308126, 4509787, 4573731, 4618083, D-346355, D-346994, D-353574; Canada 1218968, 1224230, 1235100 and; U.K. 2233036. Other patents pending.

KNAACK MANUFACTURING COMPANY  
420 E. Terra Cotta Ave, Crystal Lake, IL 60014, 1-800-456-7865  
WWW.WEATHERGUARD.COM  
©2005 Knaack Manufacturing Company

Part No. 24-0199

**KNAACK**  
MANUFACTURING  
COMPANY

  
**EMERSON**  
Professional Tools